

COR-KNOT MICRO® TECHNOLOGY GUIDE

 READ PRODUCT INSERT THOROUGHLY BEFORE USE

FIG. 1

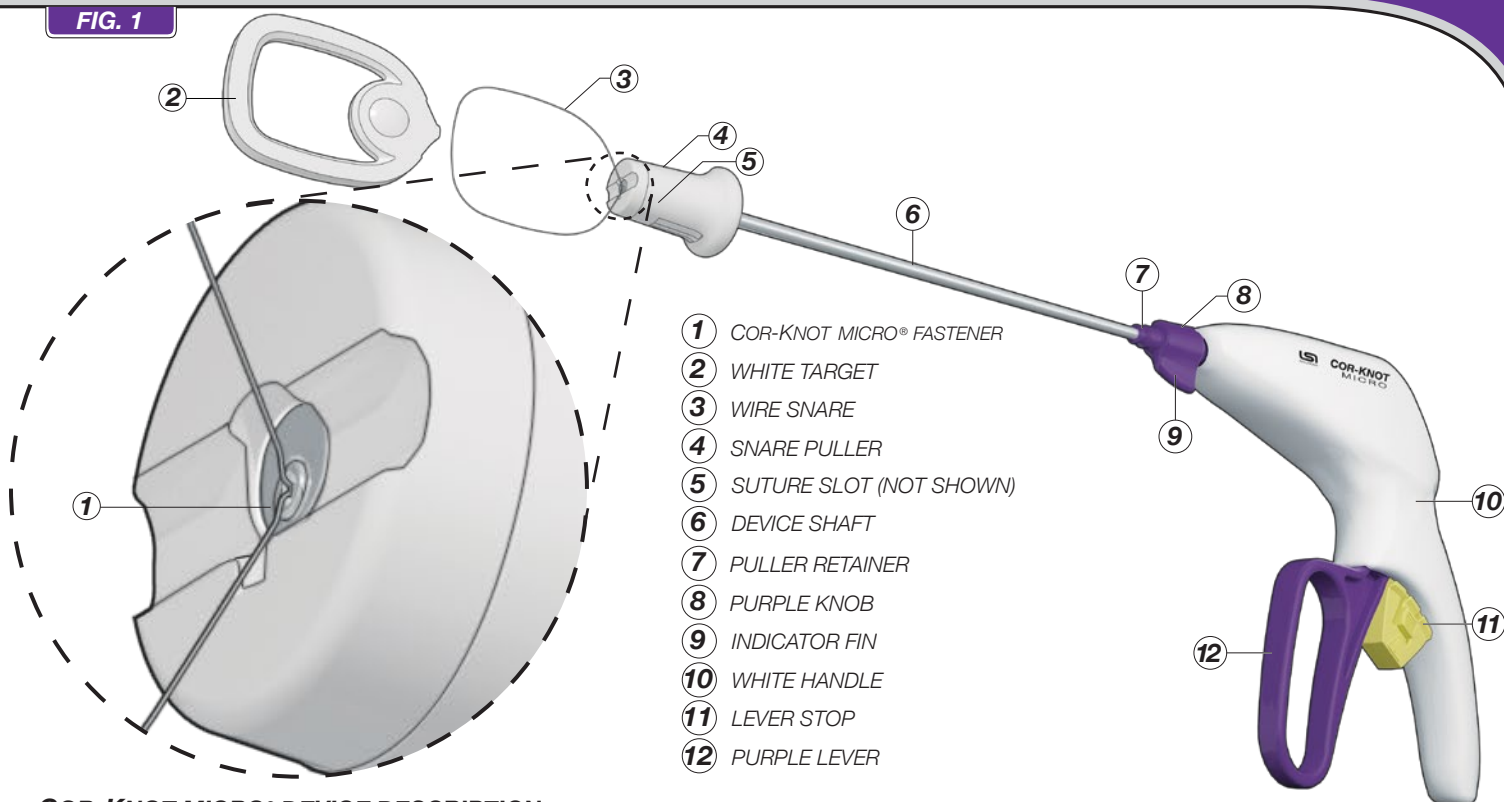

COR-KNOT MICRO® DEVICE DESCRIPTION

Each sterile *COR-KNOT MICRO® DEVICE* package contains one single-patient-use *COR-KNOT MICRO® DEVICE* preloaded with a single *COR-KNOT MICRO® FASTENER* (1). Made from medical-grade titanium, the *COR-KNOT MICRO® FASTENER* is a hollow sleeve with a rounded base. A white target (2) (shown removed above) holds the loop shape of a wire snare (3). The wire snare passes through the *COR-KNOT MICRO® FASTENER* and is attached to a snare puller (4) knob. A suture slot (5) (not shown) in the device shaft (6) lies under the opening in the snare puller. The ends of a polypropylene suture (USP 6-0, 7-0, or 8-0) are passed through the wire snare and subsequently threaded into the titanium fastener. The snare puller is pulled up or retracted along the device shaft until it snaps onto the puller retainer (7) feature of the purple knob (8), which also has an integrated indicator fin (9). The suture slot and the indicator fin are located on the same side of the device shaft. The subsequently crimped fastener and remnant trimmed suture tails bend slightly in the direction away from or opposite the suture slot and indicator fin. By rotating the purple knob and the device's white handle (10), the surgeon can ergonomically orient the direction of the suture tails, if desired. A yellow lever stop (11) is located behind the purple lever (12) to restrict inadvertent squeezing of the lever during device handling before crimping. The lever stop is removed by pinching its sides together and pulling it out of the handle. By squeezing the purple lever, the *COR-KNOT MICRO® DEVICE* crimps the *COR-KNOT MICRO® FASTENER* to fasten together segments of suture and trims away excess suture.

INDICATIONS

The *COR-KNOT MICRO® DEVICE* with *COR-KNOT MICRO® FASTENER* when used in conjunction with USP 6-0, 7-0, or 8-0 polypropylene surgical suture, is indicated for use in the approximation of soft tissue.

FIG. 2

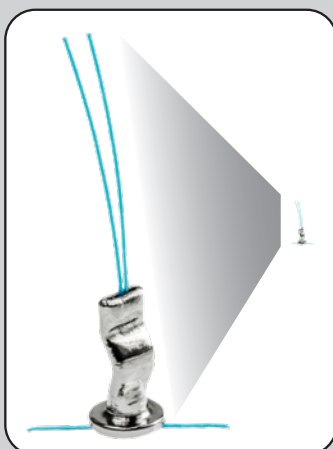

COR-KNOT MICRO® DEVICE
3mm Diameter, 14cm Length Shaft

COR-KNOT MICRO® TITANIUM FASTENER
Enlarged and Actual Size

 LS SOLUTIONS®

PREPARATION

PREPARING A COR-KNOT MICRO® DEVICE TO RECEIVE SUTURE

NOTE: The COR-KNOT MICRO® DEVICE does **NOT** require intraoperative loading of a titanium fastener. It is provided preloaded with a titanium fastener already positioned in the distal tip of the device.

Use proper operating room technique to pass the sterile COR-KNOT MICRO® DEVICE from its packaging. While maintaining appropriate sterile technique, follow the steps indicated in the illustrations. Apply appropriate hospital policy and practices to dispose of the components of this product.

1. **ENSURE** that both ends of the suture are approximately of equal length and attachments on the suture ends (e.g., needles, needle caps or ferrules, etc.) are cut away and/or removed, and no knots are in the sutures to be snared.
2. **ROTATE** the shaft's purple knob so that its indicator fin and suture slot are oriented approximately opposite the preferred direction of the trimmed suture tails.
3. **PUSH-OUT** and remove the white target from the wire snare by pressing against the target button.
4. **UNLOCK** the COR-KNOT MICRO® DEVICE by pinching the sides of the yellow lever stop and pulling it away from the handle.
5. **INSPECT** to ensure that the COR-KNOT MICRO® FASTENER is fully seated. If the fastener is not loaded properly, discard the COR-KNOT MICRO® DEVICE and obtain a new device.

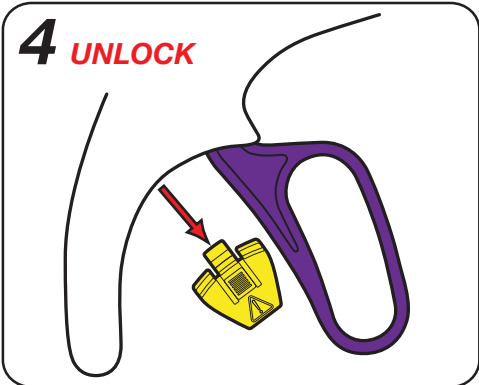
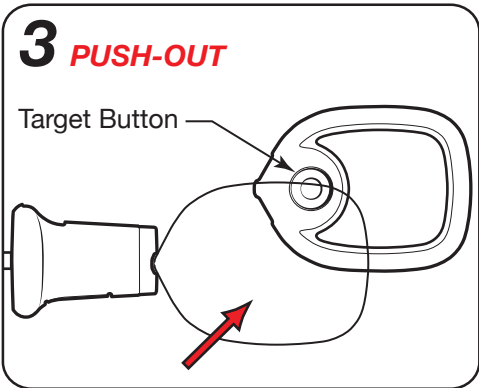
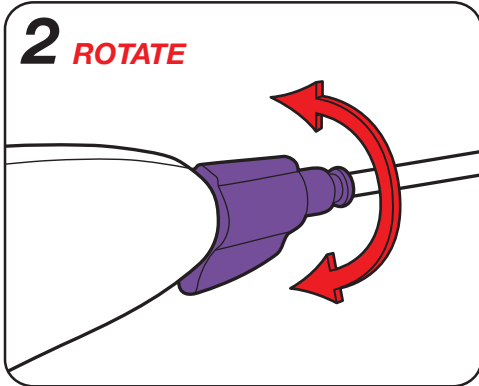
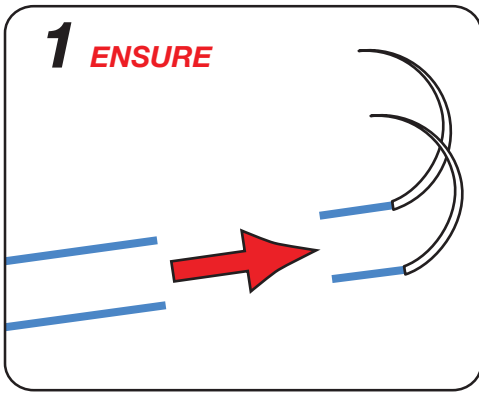
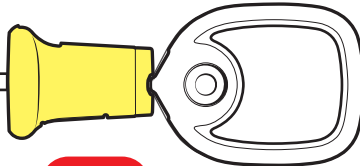

FIG. 3

IMPORTANT : PULL KNOB ONLY AFTER SUTURE IS SNARED

DO NOT MOVE



Do not move snare puller knob before pushing-out the white target or passing suture.

NEVER ROTATE

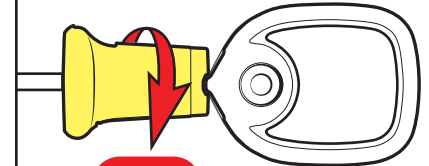

Direct rotation of snare puller knob can break the wire snare.

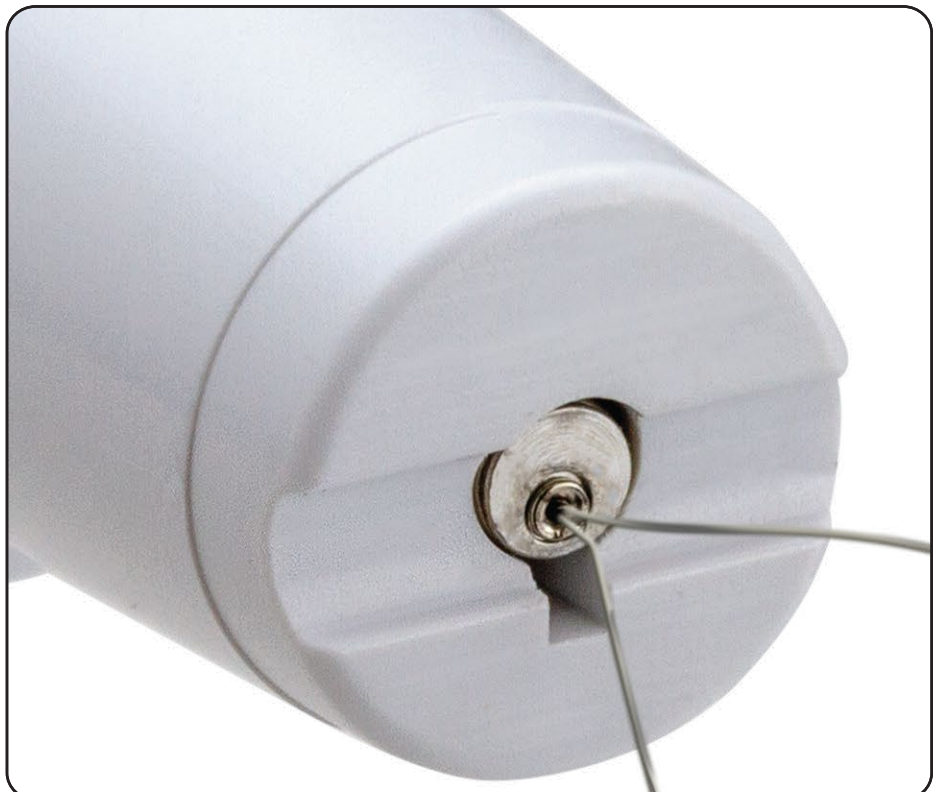

NEAR SURGICAL SITE

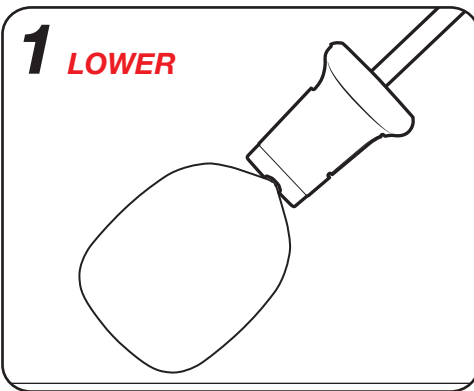

1 LOWER

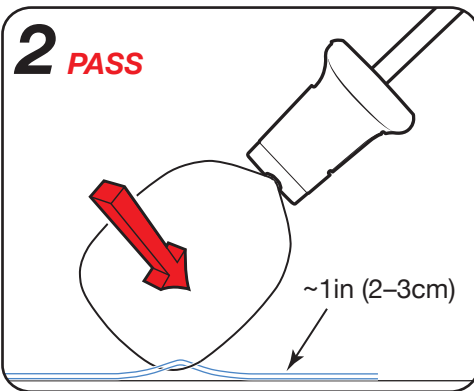

2 PASS

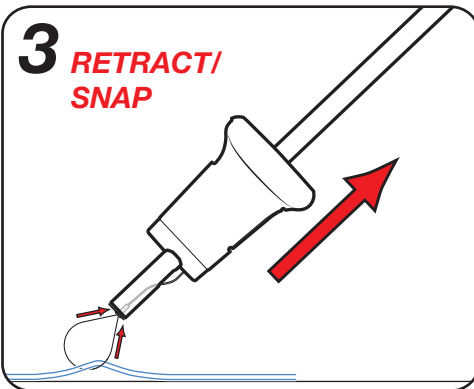

**3 RETRACT/
SNAP**

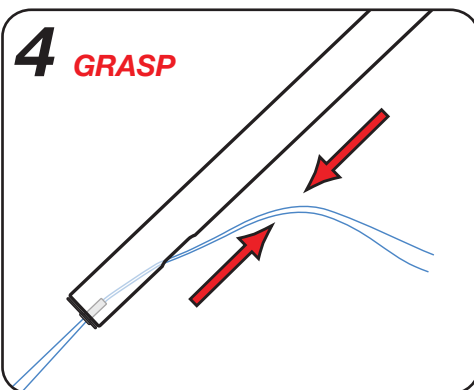

4 GRASP



5 INSPECT

THREADING SUTURE IN PRELOADED COR-KNOT MICRO® FASTENER

NOTE: Adjacent to the wound: Surgeons can use their dominant hand to hold the device's white handle and their nondominant hand to complete the suture threading technique.

- LOWER** the COR-KNOT MICRO® DEVICE tip near a sterile surface adjacent to the surgical site to avoid suture falling out of the wire snare.
- PASS** approximately 1 in (2–3cm) of both ends of the suture through the open wire snare using fingers or forceps to draw suture through. Avoid tensioning suture at the closure site.
- RETRACT** the snare puller knob up the shaft while slightly lowering the device tip to thread the suture through the COR-KNOT MICRO® DEVICE and out of the suture slot. If desired, move snare puller knob slightly back down the shaft to free suture away from the shaft. **SNAP** the snare puller knob on the snare puller retainer. When fully engaged, the snare puller knob will not slide down the shaft.
- GRASP** both suture strands and assure both ends have exited the suture slot. If both suture ends are not threaded through the suture slot, do not use the COR-KNOT MICRO® DEVICE.
- INSPECT** to ensure that the COR-KNOT MICRO® FASTENER is fully seated in the distal device tip and retains 2 strands of suture segments. If fastener is not fully seated, discard device and replace.
- SLIDE** the COR-KNOT MICRO® DEVICE distal tip gently over lightly tensioned suture down to the targeted site. If desired, rotate the white handle to **ORIENT** the indicator fin and suture slot in a direction opposite subsequently trimmed suture tails.

NOTE: The orientation of the resultant angled crimped COR-KNOT MICRO® fastener is opposite the side of the indicator fin and the suture slot.

AT CLOSURE SITE

6

SLIDE & ORIENT

NOTE: Use one continuous motion when sliding the device to the targeted site. Failure to do so, or sliding with an in and out motion, could dislodge and unseat the fastener.

NOTE: The device tip and fastener should be stabilized and flush against the targeted tissue. Avoid over-compression of the tissue.

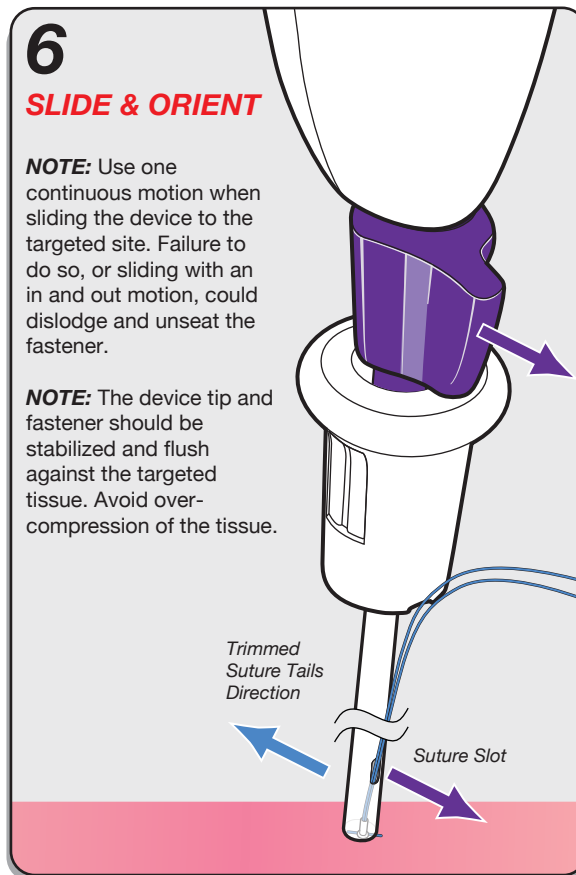

7

SQUEEZE (lever) & HOLD (1 second)

Fully squeeze **ONCE**.



8

TUG (suture) & RELEASE (lever)

Without moving the device tip, tug suture to trim. Provide full lever return.



9

PAUSE (1 second) & REMOVE (device)

Carefully and slowly withdraw device. If necessary, for easy release, gently rotate 45° in both directions about the shaft.



SQUEEZE & HOLD / TUG & RELEASE / PAUSE & REMOVE / INSPECT

With the distal tip on the targeted site, apply appropriate suture tension and:

- SQUEEZE** the purple lever once until it stops, maintain the device tip's position; **HOLD** lever for 1 second. **DO NOT RELEASE** or squeeze lever again. Fastener is now crimped. While the lever is being held, any additional tension will not be transferred to the tissue.
- TUG** the suture gently, without moving the device tip, to cut free both suture ends; fully **RELEASE** the purple lever.
- PAUSE** for 1 second; **REMOVE** device by slowly and carefully lifting up. If the crimped fastener does not readily release from the distal tip, ensure that purple lever is released, then gently rotate the white handle 45° in either direction about the shaft. If still necessary, turn the white handle back, then rotate 45° in the opposite direction. If the COR-KNOT MICRO® FASTENER still will not release, cut suture and ensure that fastener and any associated suture remnants are removed from patient.
- INSPECT** to ensure that the COR-KNOT MICRO® FASTENER and suture tails are complete and in an appropriate location.

10

INSPECT

The COR-KNOT MICRO® FASTENER and trimmed suture tails.

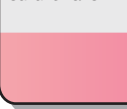

IMPORTANT: "ONLY THE SURGEON TOUCHES THE PURPLE LEVER"

FIG. 4

DO NOT SQUEEZE BEFORE THE SNARE PULLER KNOB IS SNAPPED**SQUEEZE THE PURPLE LEVER ONLY ONCE!**

FIG. 4 Snapping the snare puller knob onto the snare puller retainer ensures that the wire snare and suture are completely through the titanium fastener and device tip. If the snare puller with its wire snare is not retracted fully up the device shaft and snapped on the snare puller retainer, the wire snare can remain inside of the titanium fastener and device tip, potentially leading to suture, titanium fastener, and cutting blade damage. When ready to use, squeeze the purple lever once only, hold during suture trimming, and then release the purple lever. After releasing the lever, pause for 1 second before removing the device.

FIG. 5

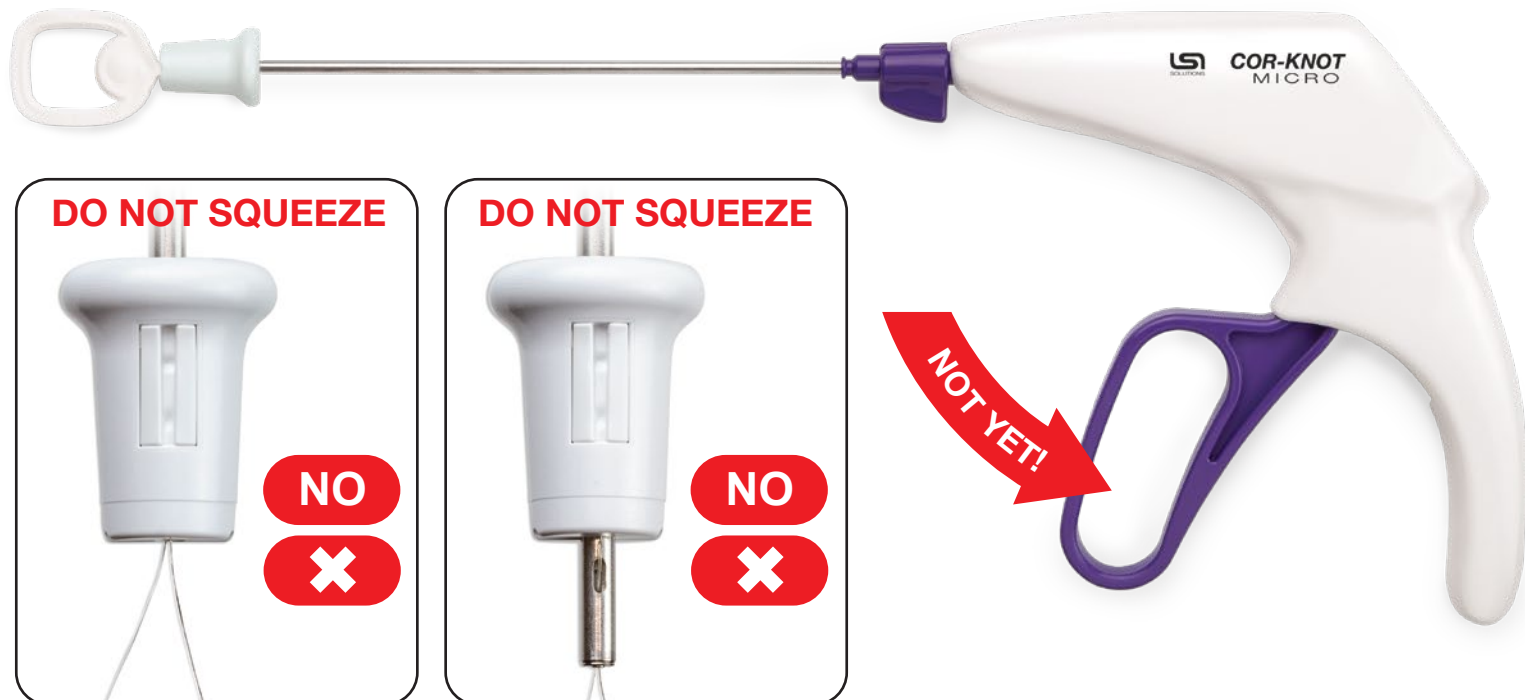

FIG. 5 Front and side enlarged views of a correctly crimped fastener

FIG. 6

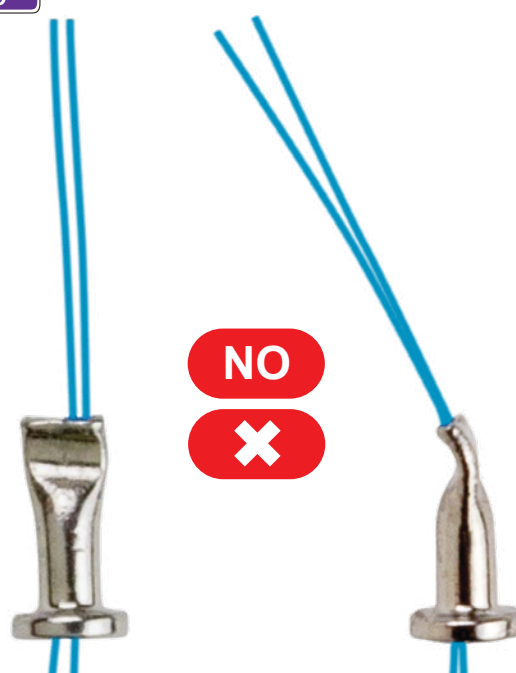

FIG. 6 For comparison, front and side enlarged views of an incorrectly crimped fastener that was not fully seated in the device tip

CONTRAINDICATIONS

- The *COR-KNOT MICRO® DEVICE* is contraindicated for use in ophthalmic and neurologic surgery.
- The *COR-KNOT MICRO® DEVICE* is not intended to be used with any fastener other than the preloaded *COR-KNOT MICRO® FASTENER*.
- The *COR-KNOT MICRO® DEVICE* is not intended to be fired more than one (1) time.
- The *COR-KNOT MICRO® FASTENER* is not marketed for placement into circulating blood.

WARNINGS

- Federal law restricts this device to sale, distribution, and use by, or on, the order of a physician.
- Users should be familiar with standard procedures and techniques involving surgical suture and titanium usage before employing the *COR-KNOT MICRO® DEVICE* for fastening and trimming suture.
- Each *COR-KNOT MICRO® DEVICE* is intended to place a single *COR-KNOT MICRO® FASTENER*.
- If the yellow lever stop is not in place when removing the *COR-KNOT MICRO® DEVICE* from the package, discard the device.
- Do not resterilize. The *COR-KNOT MICRO® DEVICE* is designed and intended for single-patient use only. Do not reuse, reload, reprocess, or resterilize this product. The performance of the *COR-KNOT MICRO® DEVICE* after cleaning or other reprocessing has not been validated and is not supported by LSI SOLUTIONS®. Reuse, reprocessing, or resterilization may compromise the integrity of the device and/or create a risk of contamination of the device, which could result in patient injury, illness, or death.
- Discard any open (unsealed), unused, expired, or damaged *COR-KNOT MICRO® DEVICE*.
- Applications other than for soft tissue approximation can result in damage to the *COR-KNOT MICRO® DEVICE*, rendering it unsuitable for continued use.
- Do not leave any foreign material (e.g., suture fragment or fastener) unattached in areas potentially exposed to circulating blood.
- When securing suture with a *COR-KNOT MICRO® DEVICE*, ensure that attachments on the suture ends (e.g., needles, needle caps or ferrules, etc.) are removed prior to loading the suture through the *COR-KNOT MICRO® DEVICE*.
- Do not squeeze the lever of the *COR-KNOT MICRO® DEVICE* until the *COR-KNOT MICRO® FASTENER* has been appropriately positioned and the suture accurately tensioned at the closure site.
- Excessive suture tensioning can cause suture breakage or tissue deformation or necrosis.
- Direct contact between sensitive tissue structures and foreign materials can lead to tissue injury or damage, such as tissue erosion. Always orient *COR-KNOT MICRO® FASTENERS* and remnant suture tails to avoid direct contact with delicate tissue.
- As with any foreign body, prolonged contact of any suture with salt solutions, such as those found in the urinary or biliary tracts, may result in calculus formation.
- Ensure that the purple lever is squeezed until it stops when actuating the *COR-KNOT MICRO® DEVICE*. Failing to complete a full squeeze on a *COR-KNOT MICRO® DEVICE* can result in a partial crimp in the titanium fastener, which could lead to a reduced holding strength. Holding the lever squeezed for a second ensures full actuation.
- Adequate *COR-KNOT MICRO® FASTENER* security requires reasonable clinical judgment and appropriate surgical techniques as warranted by individual anatomy, surgical circumstances, and the experience of the surgeon.
- Each *COR-KNOT MICRO® DEVICE*, along with packaging, must be inspected, handled, and disposed of consistent with standard, accepted medical device disposal procedures.
- While the titanium of the *COR-KNOT MICRO® FASTENER* is physiologically very inert, routine surgical precautions must be employed whenever foreign materials are left in a patient.

PRECAUTIONS

- When handling the *COR-KNOT MICRO® DEVICE*, care should be taken to avoid damage.
- Surgical procedures should only be performed by physicians having adequate training and familiarity with such techniques. In addition, medical literature should be consulted relative to techniques, complications, and hazards prior to the performance of surgical procedures. Inappropriate actions or use can lead to patient harm or death.
- Avoid damage to the *COR-KNOT MICRO® DEVICE* due to inappropriate squeezing of the purple lever and/or due to application of surgical instruments like forceps, needle holders, clamps, etc.
- Do not use the *COR-KNOT MICRO® DEVICE* to aggressively manipulate tissue structures.
- Before instruments and accessories from different manufacturers are employed together in a procedure, verify compatibility and ensure that electrical isolation or grounding are not compromised.
- Ensure that inappropriate obstructions do not interfere with the firing of the *COR-KNOT MICRO® DEVICE*; obstructions may cause damage or breakage.
- If the *COR-KNOT MICRO® FASTENER* falls out of the device tip or is not properly loaded or seated, discard the *COR-KNOT MICRO® DEVICE* and *COR-KNOT MICRO® FASTENER*.
- Irreparable damage to the *COR-KNOT MICRO® DEVICE* and fastener can occur if the purple lever is squeezed while the wire snare is in place at the tip of the device.
- Do not squeeze the purple lever on the same *COR-KNOT MICRO® DEVICE* more than once.
- If the purple lever of the *COR-KNOT MICRO® DEVICE* does not return completely forward on its own (i.e., without assistance), manually push the purple lever forward all the way until it stops to provide full lever release.
- Trim suture ends with scissors if the *COR-KNOT MICRO® DEVICE* makes a successful crimp but does not cut suture.
- If *COR-KNOT MICRO® DEVICE* makes an unsuccessful crimp, manually cut suture to remove fastener and suture.
- Check for hemostasis or leakage where appropriate.
- Avoid crushing or crimping damage to the *COR-KNOT MICRO® FASTENER* due to inappropriate squeezing of the *COR-KNOT MICRO® DEVICE* purple lever and/or due to application of surgical instruments like forceps, needle holders, clamps, etc.
- Inspect each *COR-KNOT MICRO® FASTENER* and its suture tails.

ACTIONS

When the *COR-KNOT MICRO® DEVICE* preloaded with a *COR-KNOT MICRO® FASTENER* is appropriately positioned at a suture closure site, squeezing the purple lever can instantly secure the fastener and trim the suture. LSI SOLUTIONS® has demonstrated that the *COR-KNOT MICRO® DEVICE* and *COR-KNOT MICRO® FASTENER* meet USP minimum values for tensile strength when used within the average range of USP diameters for 6-0, 7-0, and 8-0 polypropylene suture that complies with USP standards for surgical suture. The surgical titanium used in a *COR-KNOT MICRO® FASTENER* is not absorbed by the body; surgical titanium is generally not associated with significant inflammatory reactions.

ADVERSE REACTIONS

Adverse effects associated with the use of surgical suture and titanium can include, but are not limited to: wound dehiscence, thrombus formation, embolism, calculi formation in urinary and biliary tracts when prolonged contact with salt solutions such as urine and bile occurs, infected wounds, minimal acute inflammatory tissue reaction, bleeding, and transitory local irritation. Surgical titanium is not absorbed by the body and is generally not associated with significant inflammatory reactions. Direct contact between sensitive tissue structures and foreign materials can lead to tissue injury or damage, such as tissue erosion.

MRI Testing

Based on MRI testing information, a titanium *COR-KNOT MICRO® FASTENER* will not present an additional hazard or risk to a patient undergoing an MRI procedure using a scanner operating with a static magnetic field of 3 Tesla or less and under the MRI-related heating conditions (MRI for 15 minutes at an MR system reported whole body averaged specific absorption rate (SAR) value of 2W/kg).

NOTE: The average weight of *COR-KNOT MICRO® FASTENER* is 0.002g; 1/6 the weight of a *COR-KNOT® FASTENER*.

MRI Safety Information – MR Conditional  Nonclinical testing demonstrated that the titanium *COR-KNOT MICRO® FASTENER* is MR Conditional. A patient with this device can be scanned safely in an MR system under the following conditions: static magnetic field of 1.5 Tesla and 3 Tesla only; maximum spatial gradient magnetic field of 4,000 Gauss/cm (40T/m); and maximum MR system reported whole body averaged specific absorption rate (SAR) of 2W/kg for 15 minutes of scanning (i.e., per pulse sequence) in the Normal Operating Mode. Under the scan conditions defined, the titanium *COR-KNOT MICRO® FASTENER* is expected to produce a maximum temperature rise of 1.5°C after 15 minutes of continuous scanning (i.e., per pulse sequence). In nonclinical testing, the image artifact caused by the titanium *COR-KNOT MICRO® FASTENER* extends approximately 2mm from this implant when imaged using a gradient echo pulse sequence and a 3 Tesla MR system. Reference: ASTM 2503, *Standard Practice for Marking Medical Devices and Other Items for Safety in the Magnetic Resonance Environment*

COR-KNOT MICRO® FASTENER			
Knot Strength Relative to USP			
USP Size	USP Avg. Diameter Range for Polypropylene Suture	USP Knot Pull Tensile Strength (minimum)	<i>COR-KNOT MICRO® FASTENER</i> Knot Pull Tensile Strength Relative to USP Standard
6-0	0.070–0.099mm 0.0028–0.0039in	0.20kgf	>100%
7-0	0.050–0.069mm 0.0020–0.0027in	0.11kgf	>100%
8-0	0.040–0.049mm 0.0016–0.0019in	0.06kgf	>100%

COR-KNOT MICRO® PRODUCT ORDERING

SUPPLIED: STERILE

REORDER

PRODUCT

DESCRIPTION

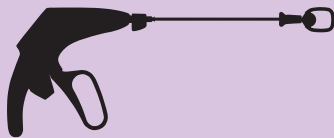

REF 032500

COR-KNOT MICRO® DEVICE
Pre-Loaded with (1) titanium
COR-KNOT MICRO® FASTENER

Box of 6 Kits
(1 Device per Kit)

LSI SOLUTIONS®

The LSI logo, LSI SOLUTIONS, Cor-Knot, Cor-Knot Micro, and Perfect Performance Policy are trademarks and registered trademarks of LSI Solutions, Inc. Copyright © 2020, LSI SOLUTIONS®. All Rights Reserved.

Patents: www.lsisolutions.com/patents



Symbol Glossary: www.lsisolutions.com/symbols



LSI SOLUTIONS®

7796 Victor-Mendon Road
Victor, New York 14564 U.S.A.

Phone: 585.869.6600

Customer Service: 866.575.3493

Technical Support: 866.428.9092

Fax: 585.742.8086

www.lsisolutions.com

MADE IN THE USA

This Product Comes
with our LSI SOLUTIONS®
Perfect Performance Policy®
Call us at 866.575.3493 any time.