

COR-KNOT® EU TECHNOLOGY GUIDE

 READ PRODUCT INSERT THOROUGHLY BEFORE USE

FIG. 1

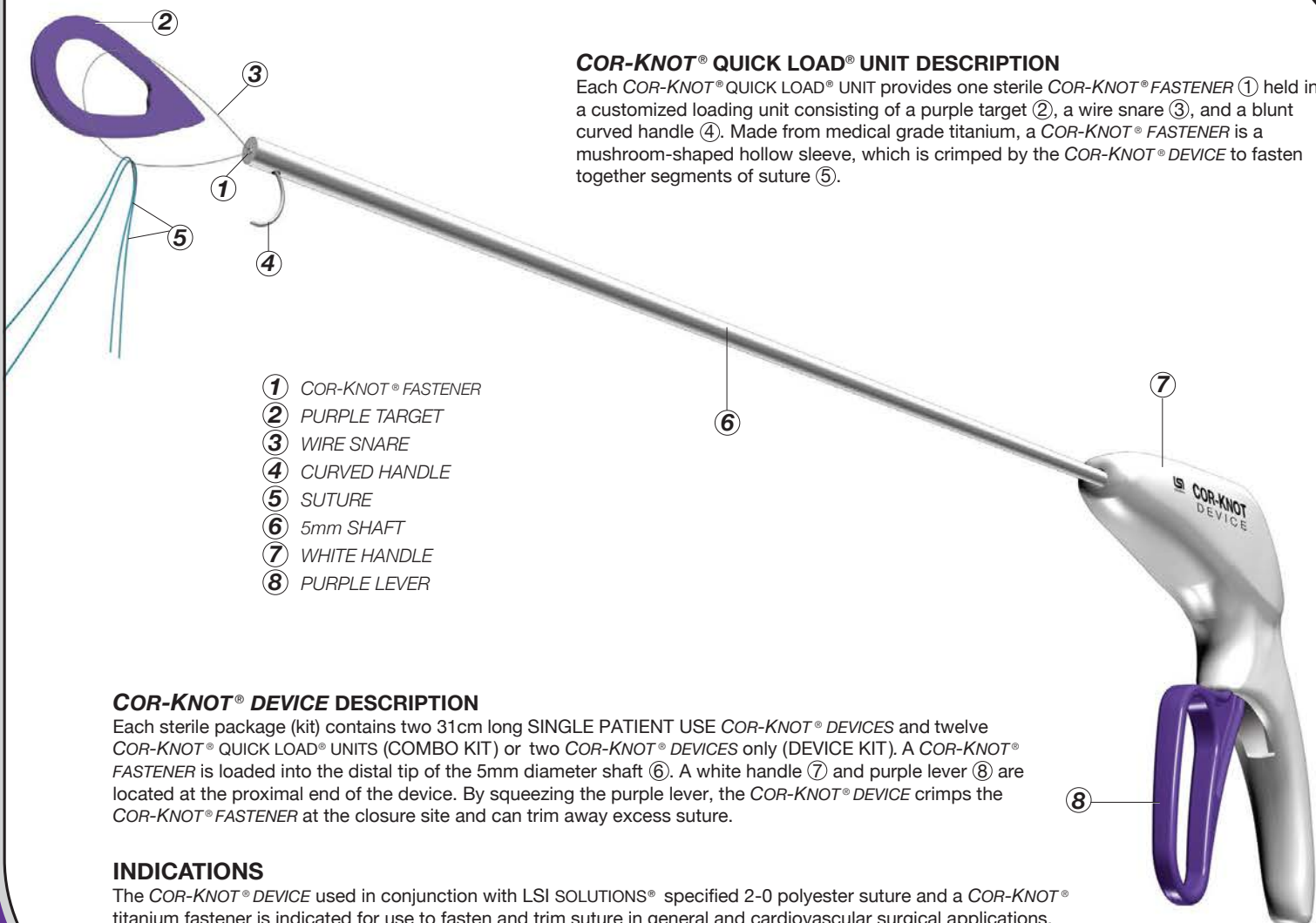
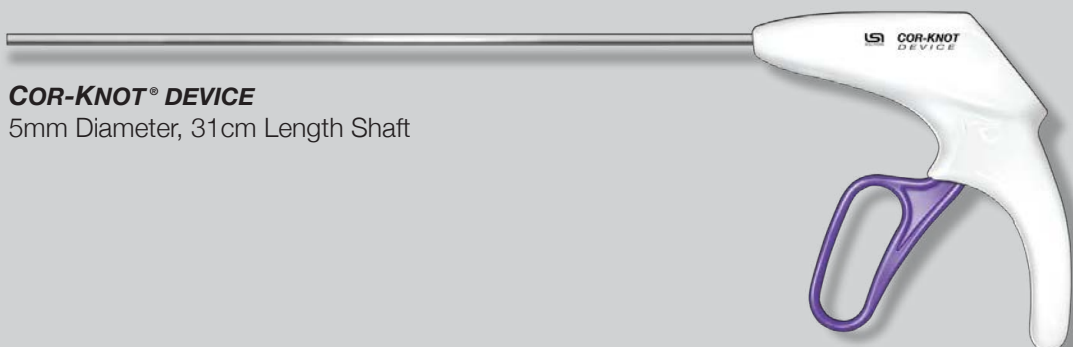

FIG. 2



Courtesy of Peter A. Knight, M.D.

COR-KNOT® DEVICE
5mm Diameter, 31cm Length Shaft



LSI SOLUTIONS®

AT SCRUB TABLE

1 INSERT

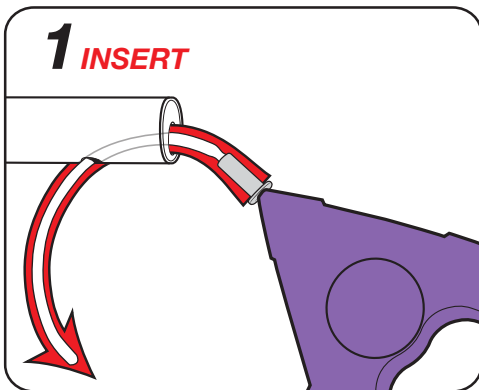

2 PUSH-OUT

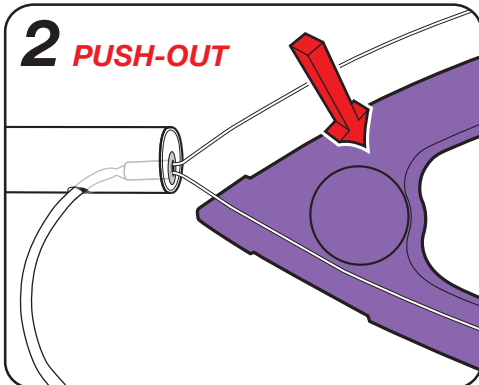

3 RELEASE

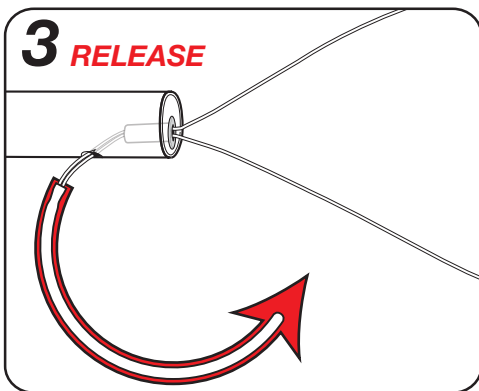

4A INSPECT

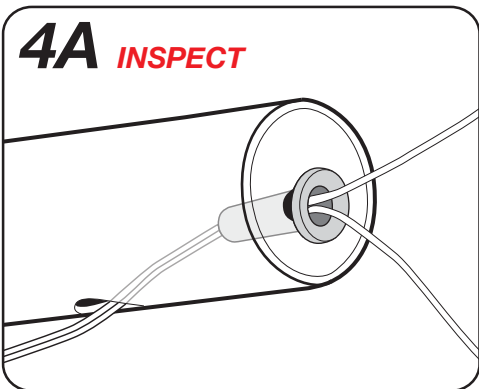

4B

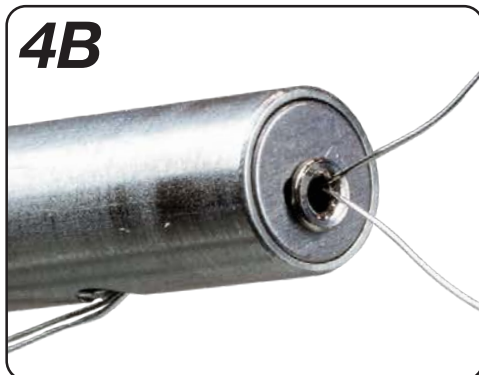

LOADING WITH A COR-KNOT® QUICK LOAD® UNIT

Use proper operating room technique to pass the sterile COR-KNOT® QUICK LOAD® UNIT from its packaging. While maintaining appropriate sterile technique, follow the steps indicated in the illustrations.

1. **INSERT** the blunt tip of the curved handle into the distal slot at the end of the COR-KNOT® DEVICE shaft. ROTATE the curved handle through the distal slot and out of the suture hole until the COR-KNOT® FASTENER occupies the shaft's distal slot. Fully ENGAGE the COR-KNOT® FASTENER within the tip of the COR-KNOT® DEVICE by pushing on the purple target or by pulling on the curved handle.
 2. **PUSH-OUT** and remove the purple target.
 3. **RELEASE** the curved handle from the distal slot at the end of the COR-KNOT® DEVICE shaft.
- 4A/B. **INSPECT** to ensure that the COR-KNOT® FASTENER is well loaded and fully seated.

ACTIONS

When the COR-KNOT® DEVICE is loaded with a COR-KNOT® FASTENER and appropriately positioned at a suture closure site, squeezing the purple lever can instantly secure and trim the suture. The surgical titanium used in a COR-KNOT® FASTENER is not absorbed by the body and is generally not associated with significant inflammatory reactions.

CONTRAINDICATIONS

- Endoscopic procedures should only be performed by physicians having adequate training and familiarity with endoscopic techniques. Medical literature should be consulted relative to techniques, complications and hazards prior to the performance of endoscopic procedures.
- The COR-KNOT® QUICK LOAD® UNIT is not intended to be used with any device other than the COR-KNOT® DEVICE or the COR-KNOT® MINI® DEVICE. The COR-KNOT® DEVICE is not intended to be loaded with anything other than a COR-KNOT® QUICK LOAD® UNIT.
- The COR-KNOT® FASTENER is NOT intended for placement into circulating blood unless used with compatible suture under conditions judged by the surgeon to be clinically appropriate.
- Use only with LSI SOLUTIONS® specified 2-0 polyester suture.
- Each COR-KNOT® DEVICE is not intended to be fired more than 12 times.

WARNINGS

- Users should be familiar with standard procedures and techniques involving surgical suture and titanium usage before employing the COR-KNOT® DEVICE with a COR-KNOT® QUICK LOAD® UNIT for fastening and trimming suture.
- Adequate COR-KNOT® FASTENER security requires reasonable clinical judgment and appropriate surgical techniques as warranted by surgical circumstances and the experience of the surgeon.
- When securing suture with a COR-KNOT® DEVICE, ensure any needle caps or needles are removed from the suture ends to be loaded prior to loading the suture through the COR-KNOT® DEVICE.
- Excessive suture tensioning can cause suture breakage.
- Single patient use only. Do not reclean or resterilize. Adequate cleaning or removal of blood and other foreign materials from used COR-KNOT® products cannot be guaranteed. Validation of resterilization is not established. Failure to eliminate inflammatory or infectious agents may cause patient harm. Product functional performance may be compromised in reprocessed devices or COR-KNOT® FASTENERS.
- Discard any open (unsealed), unused, expired or damaged COR-KNOT® product.
- COR-KNOT® QUICK LOAD® UNIT components and each COR-KNOT® DEVICE, along with packaging, must be inspected, handled and disposed of consistent with standard, accepted medical device disposal procedures.
- Direct contact between sensitive tissue structures (e.g., pulsatile arteries, cardiac valve leaflets, valve chordae, etc.) and foreign materials can lead to tissue injury or damage, such as tissue erosion. Always orient COR-KNOT® FASTENERS and remnant suture tails to avoid direct contact between delicate tissue or prosthetic structures.
- As with any foreign body, prolonged contact of any suture with salt solutions, such as those found in the urinary or biliary tracts, may result in calculus formation.
- While the titanium of the COR-KNOT® FASTENER is physiologically very inert, routine surgical precautions must be employed whenever foreign materials are left in a patient.

PRECAUTIONS

- When handling the COR-KNOT® QUICK LOAD® UNIT care should be taken to avoid damage.
- Do not squeeze the purple lever of COR-KNOT® DEVICE while loading the COR-KNOT® QUICK LOAD® UNIT.
- Irreparable damage to COR-KNOT® DEVICE suture cutting blade will occur if the purple lever is squeezed while the COR-KNOT® QUICK LOAD® UNIT curved handle is in place at the tip of the instrument.
- Ensure that obstructions do not interfere with the firing of COR-KNOT® DEVICE.
- Do not squeeze the purple lever of the loaded COR-KNOT® DEVICE, until the COR-KNOT® FASTENER has been appropriately positioned directly upon the tissue or prosthetic material and the suture accurately tensioned at the targeted site.
- Always squeeze and hold the purple lever and then fully release it before moving the COR-KNOT® DEVICE tip. Failure to appropriately release the purple lever can cause suture breakage. Inspect each COR-KNOT® FASTENER and its suture tails.
- Do not squeeze the purple lever on the same COR-KNOT® FASTENER more than once.
- Cut suture with scissors if the COR-KNOT® DEVICE fails to trim suture or release COR-KNOT® FASTENER.
- Avoid crushing or crimping damage to the COR-KNOT® FASTENER due to inappropriate squeezing of COR-KNOT® DEVICE purple lever and/or to application of surgical instruments like forceps, needle holders, clamps, etc.
- If COR-KNOT® FASTENER falls out of tip or is not properly loaded, retrieve loose fastener, reload with new fastener and start again.
- If the purple lever of the COR-KNOT® DEVICE does not return completely forward on its own (i.e., without assistance), manually push the lever forward all the way to release the COR-KNOT® FASTENER.
- Check for hemostasis or leakage where appropriate.
- Before endoscopic instruments and accessories from different manufacturers are employed together in a procedure, verify compatibility and ensure that electrical isolation or grounding are not compromised.

ADVERSE REACTIONS

Adverse effects associated with the use of surgical suture and titanium can include, but are not limited to: wound dehiscence, thrombus formation, embolism, calculi formation in urinary and biliary tracts when prolonged contact with salt solutions such as urine and bile occurs, infected wounds, minimal acute inflammatory tissue reaction, and transitory local irritation. Surgical titanium is not absorbed by the body and is generally not associated with inflammatory reactions. Any serious incident that has occurred in relation to the device should be reported to the manufacturer and the country competent authority.

OUTSIDE OF PATIENT

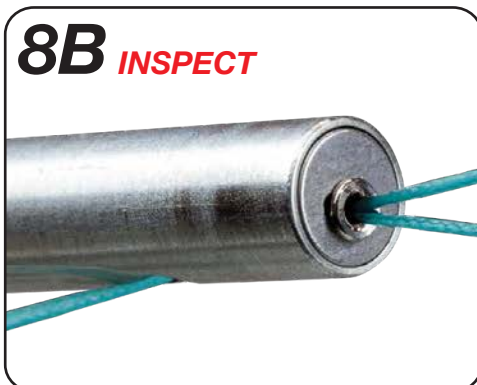
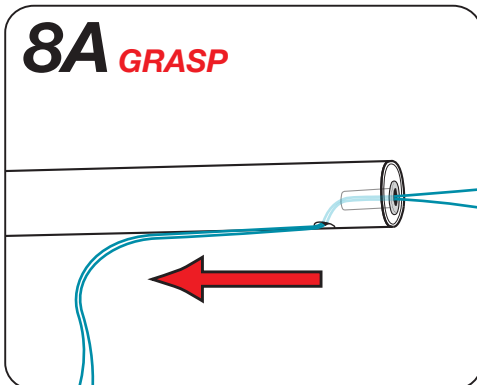
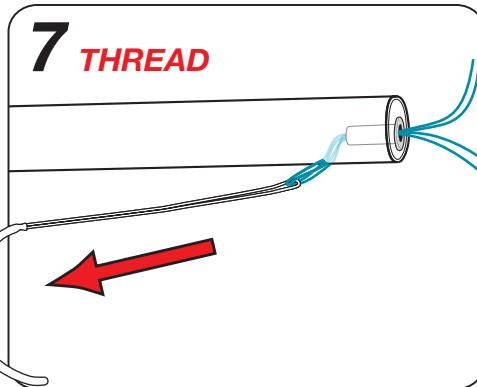
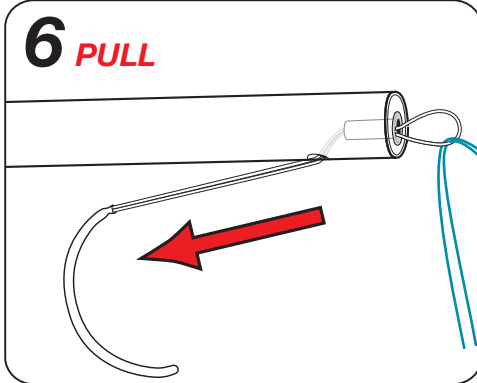
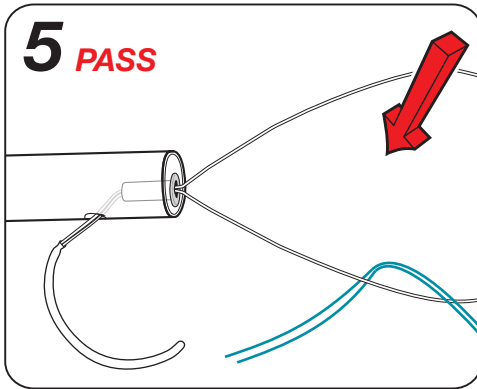

THREADING SUTURE THROUGH A LOADED COR-KNOT® FASTENER

Extracorporeally: surgeons typically use their non-dominant hand to hold the device near the end of its shaft and their dominant hand to complete the suture threading technique.

5. **PASS** both ends of the suture through the open wire snare at the end of the shaft.
6. **PULL** the curved handle with its attached wire snare containing the suture ends towards the purple lever to draw the snared bends in the suture into the **COR-KNOT® FASTENER**.
7. **THREAD** the suture through the **COR-KNOT® FASTENER** and out of the suture hole near the end of the shaft by continuing to pull the curved handle until the wire snare and both ends of the suture exit through the suture hole.
- 8A. **GRASP** both ends of the suture after passing off the curved handle with the wire snare.
- 8B. **INSPECT** to ensure fastener is fully seated in distal device tip.

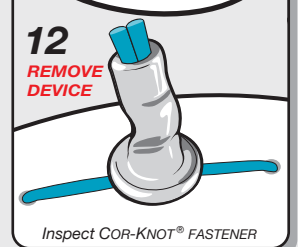
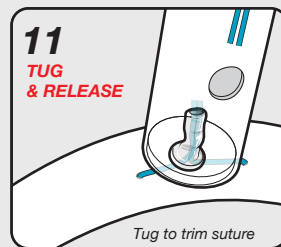
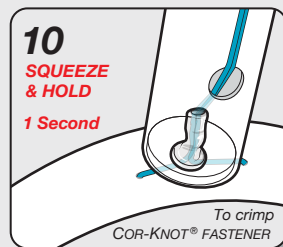
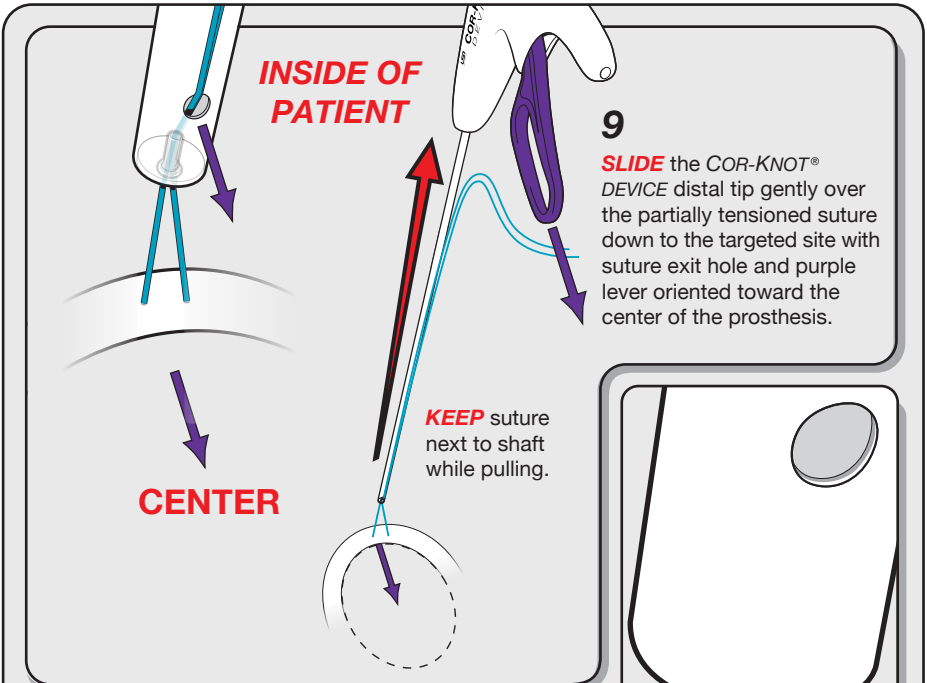

SQUEEZE & HOLD / TUG & RELEASE / REMOVE DEVICE

With the distal tip on the prosthetic, use one hand to apply sufficient suture tension to hold tissue and prosthetic in appropriate apposition, then the other hand to:

10. **SQUEEZE** the purple lever until it stops, maintain the device tip's position, **HOLD** lever for one second.
11. **TUG** the suture gently to cut free both suture ends and **RELEASE** the purple lever fully to release the crimped **COR-KNOT® FASTENER**.
12. **REMOVE DEVICE** and inspect to ensure **COR-KNOT® FASTENER** and suture tails are oriented away from delicate tissue and prosthetic structures.

PLEASE NOTE

While abruptly squeezing and releasing of the purple lever provides average suture holding forces above EP and USP standards, this recommended **SQUEEZE & HOLD** technique assures optimized suture holding force. Visually inspect each suture tail and **COR-KNOT® FASTENER**.

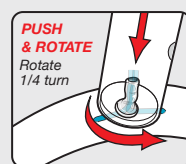

If the crimped **COR-KNOT® FASTENER** does not readily release from the distal tip, ensure purple lever is released, then gently **PUSH** inward and **ROTATE** the handle 90° about the shaft. If still necessary, **ROTATE** the handle back, then turn 90° in the opposite direction. If **COR-KNOT® FASTENER** will still not release, cut suture.

FAILURE TO PROPERLY LOAD SUTURE

NOTE: TO REMOVE A RETAINED **COR-KNOT® FASTENER** IF THE WIRE SNARE IS INADVERTENTLY REMOVED WITHOUT PROPER SUTURE THREADING, SQUEEZE AND RELEASE THE PURPLE LEVER AND THEN TAP THE DISTAL SHAFT ON A TABLE OR USE A SCALPEL TO PRY OUT THE CRIMPED **COR-KNOT® FASTENER**.

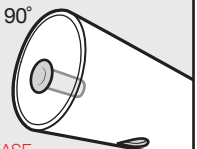
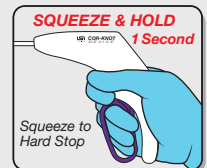

COR-KNOT[®] QUICK LOAD[®] UNIT

 READ PRODUCT INSERT THOROUGHLY BEFORE USE

FIG. 3

CRIMPED COR-KNOT[®] FASTENER

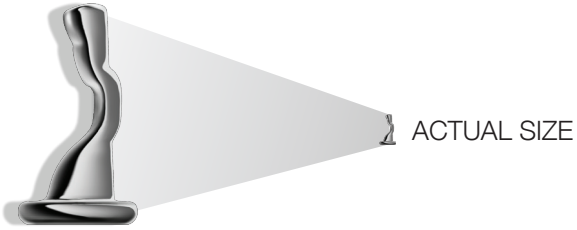

COR-KNOT[®] QUICK LOAD[®] UNIT DESCRIPTION

Each COR-KNOT[®] QUICK LOAD[®] UNIT provides one sterile COR-KNOT[®] FASTENER ① held in a customized loading unit consisting of a purple target ②, a wire snare ③, and a blunt curved handle ④. Made from medical grade titanium, a COR-KNOT[®] FASTENER is a mushroom-shaped hollow sleeve, which is crimped by the COR-KNOT[®] DEVICE to fasten together segments of suture.

OVERALL QUALITATIVE AND QUANTITATIVE COMPOSITION

The only portion of the COR-KNOT[®] QUICK LOAD[®] UNIT which is an implant is the COR-KNOT[®] FASTENER, which is made up of 100% commercially pure titanium.

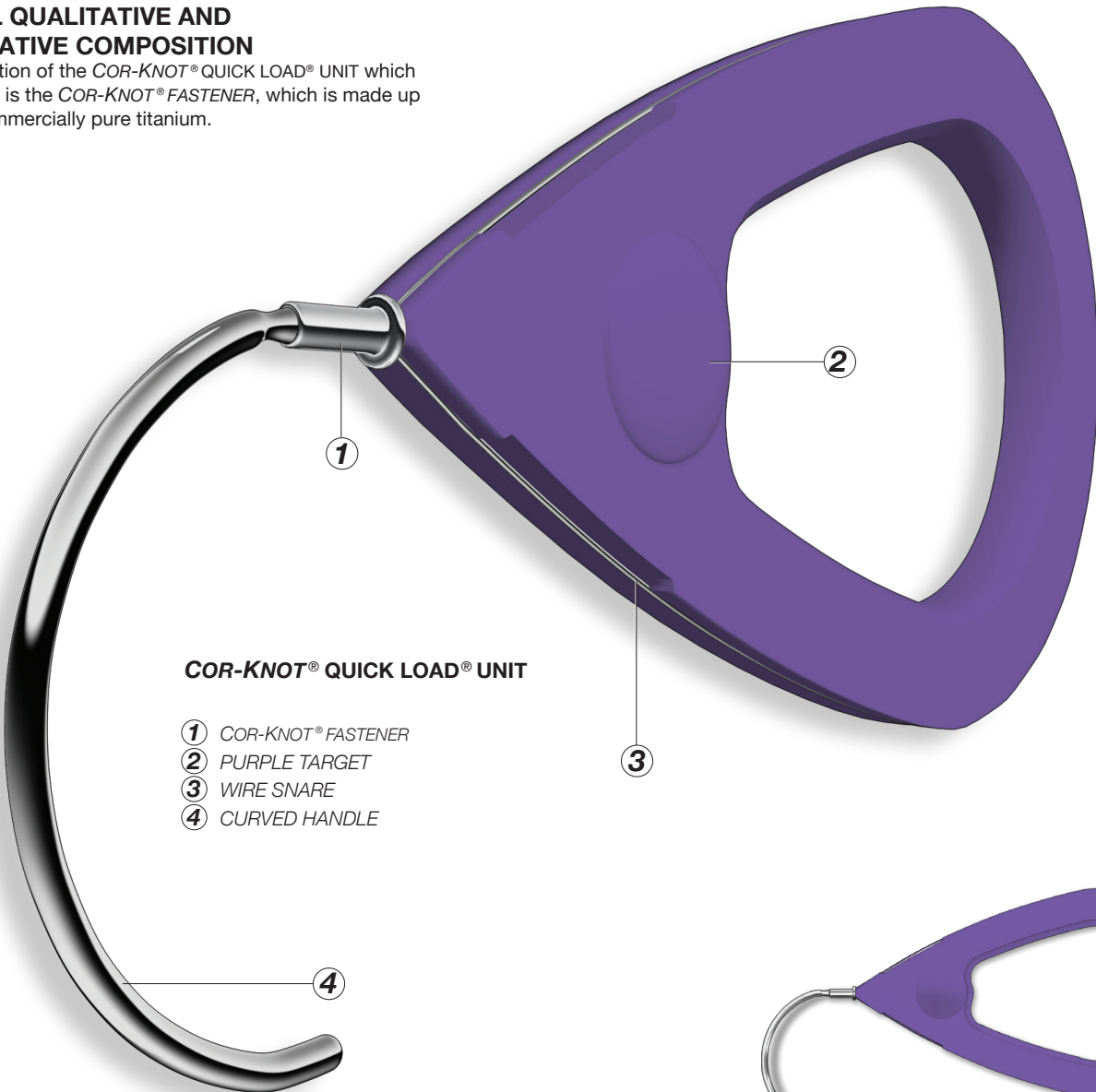

COR-KNOT[®] QUICK LOAD[®] UNIT

- ① COR-KNOT[®] FASTENER
- ② PURPLE TARGET
- ③ WIRE SNARE
- ④ CURVED HANDLE

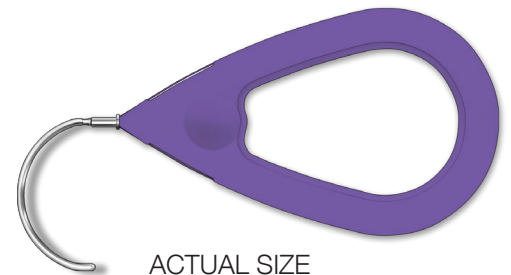

COR-KNOT® MISCELLANEOUS

“ONLY THE SURGEON SQUEEZES THE PURPLE LEVER”

SUTURE CUTTING DIFFICULTY - THE CAUSES OF SUTURE NOT CUTTING EASILY WHEN USING A COR-KNOT® DEVICE CAN INCLUDE:

- USER ERROR INDUCED DAMAGE DULLING THE SUTURE CUTTING BLADE OR
- DEVICE MALFUNCTION, WHICH MAY ALSO REDUCE FASTENER STRENGTH AND SECURITY

If suture cutting difficulty occurs while using any COR-KNOT® DEVICE, discontinue its intraoperative use and REMOVE DEVICE from the surgical field. Visually INSPECT FASTENER to compare its crimp to other fasteners. Pull or tug on the fastener with a forceps or clamp to TEST FASTENER and suture security.

REMOVE DEVICE-INSPECT FASTENER-TEST FASTENER-RETURN DEVICE

COR-KNOT® DEVICE suture cutting difficulty can be induced by the inadvertent squeezing of the purple lever while the metal loading components are still in the distal device shaft. This user error can lead to irreparable damage to the suture cutting blade by driving the blade into the metal curved handle or metal wire snare.

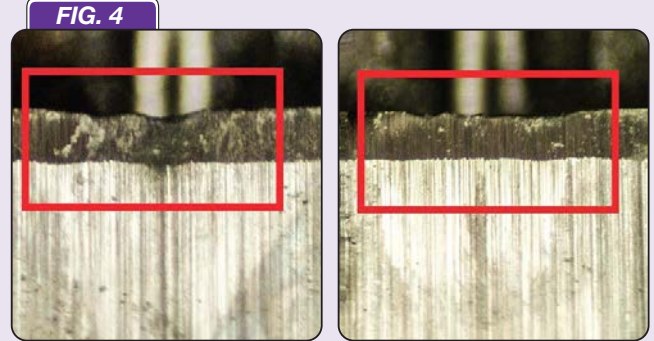

The photographs above show close-up views of two suture cutting blades from two devices damaged in the same surgical procedure. The subsequent evaluation of the returned devices demonstrated irreparable blade dulling caused by user error. The red rectangles highlight the areas of each blade's previously sharp cutting edge now dulled by the unintended striking of the blade into the metal loading unit components.



MRI SAFETY INFORMATION – MR CONDITIONAL

Non-clinical testing demonstrated that the COR-KNOT® Titanium Fastener is MR Conditional. A patient with this device can be scanned safely in an MR system under the following conditions:

- Static magnetic field of 1.5-Tesla and 3-Tesla, only
- Maximum spatial gradient magnetic field of 4,000-Gauss/cm (40-T/m)
- Maximum MR system reported, whole body averaged specific absorption rate (SAR) of 2-W/kg for 15 minutes of scanning (i.e., per pulse sequence) in the Normal Operating Mode.

Under the scan conditions defined, the COR-KNOT® Titanium Fastener is expected to produce a maximum temperature rise of 1.5°C after 15-minutes of continuous scanning (i.e., per pulse sequence).

In non-clinical testing, the image artifact caused by the COR-KNOT® Titanium Fastener extends approximately 2-mm from this implant when imaged using a gradient echo pulse sequence and a 3-Tesla MR system.



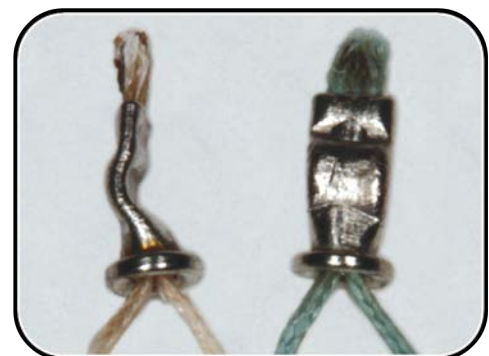

HARVESTED AT 18 MONTHS

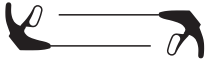

Courtesy of Scott M. Goldman, M.D.

FIG. 6 COR-KNOT® MIS PRODUCT ORDERING

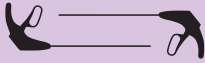
SUPPLIED: STERILE

| | REORDER | PRODUCT | DESCRIPTION |
|--|------------|--------------------------------------|--|
|  x 6 | REF 030925 | COR-KNOT® DEVICE KIT | Box of 6 Kits (2 Devices per Kit) |
|  x 12 | REF 030950 | COR-KNOT® QUICK LOAD® SINGLES | Box of 12 Singles (1 Fastener per Pouch) |
|  x 12 | REF 030902 | COR-KNOT® QUICK LOAD® 6-POUCH | Box of 12 Pouches (6 Fasteners per Pouch) |
|  x 6  x 6 | REF 031105 | COR-KNOT® COMBO KIT | Box of 6 Kits (2 Devices & 12 Fasteners per Kit) |

INTRA OP



Courtesy of Peter A. Knight, M.D.

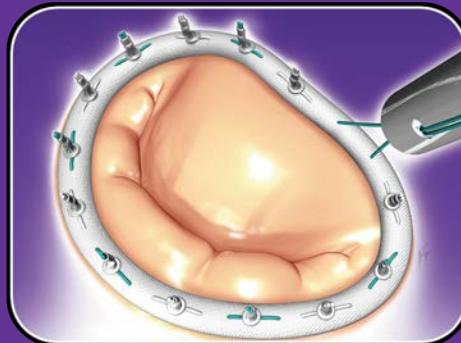

3D ECHO

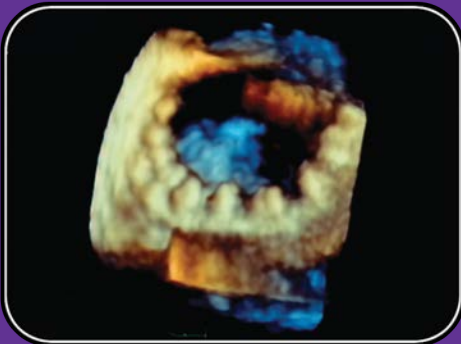

Courtesy of Peter A. Knight, M.D.

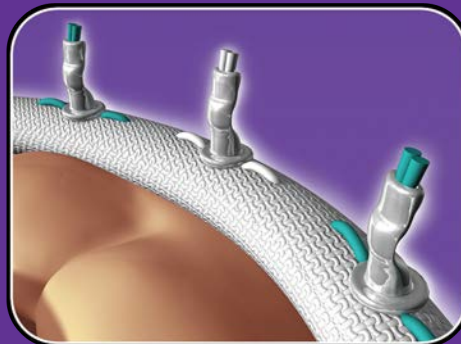

Courtesy of Peter A. Knight, M.D.

LSI SOLUTIONS®

The Summary of Safety and Clinical Performance (SSCP) Report, with information on device suitability and patient target group, shall be made available in the European database on medical devices (EUDAMED) at <http://ec.europa.eu/tools/eudamed> once the database is publicly accessible. The Basic UDI-DI for this device is 0850200006COR-KNOT2N.

Patents: www.lsisolutions.com/patents

The LSI logo, LSI SOLUTIONS, Cor-Knot, Cor-Knot Mini, Quick Load, and Perfect Performance Policy are trademarks and registered trademarks of LSI Solutions, Inc. Copyright © 2010, LSI SOLUTIONS®. All Rights Reserved.



QTY An indication of the net quantity of contents.

Symbol Glossary: www.lsisolutions.com/symbols



LSI SOLUTIONS®
7796 Victor-Mendon Road
Victor, New York 14564 U.S.A.
Phone: +1.585.869.6600
Customer Service: +1.866.575.3493
Technical Support: +1.866.428.9092
Fax: +1.585.742.8086
www.lsisolutions.com



EMERGO EUROPE
Westervoortsedijk 60
6827 AT Arnhem
The Netherlands



MADE IN THE USA

This Product Comes
with our LSI SOLUTIONS®
Perfect Performance Policy®
Call us at +1.866.575.3493 any time.