

# TK® DEVICE TECHNOLOGY GUIDE

READ PRODUCT INSERT THOROUGHLY BEFORE USE

FIG. 1

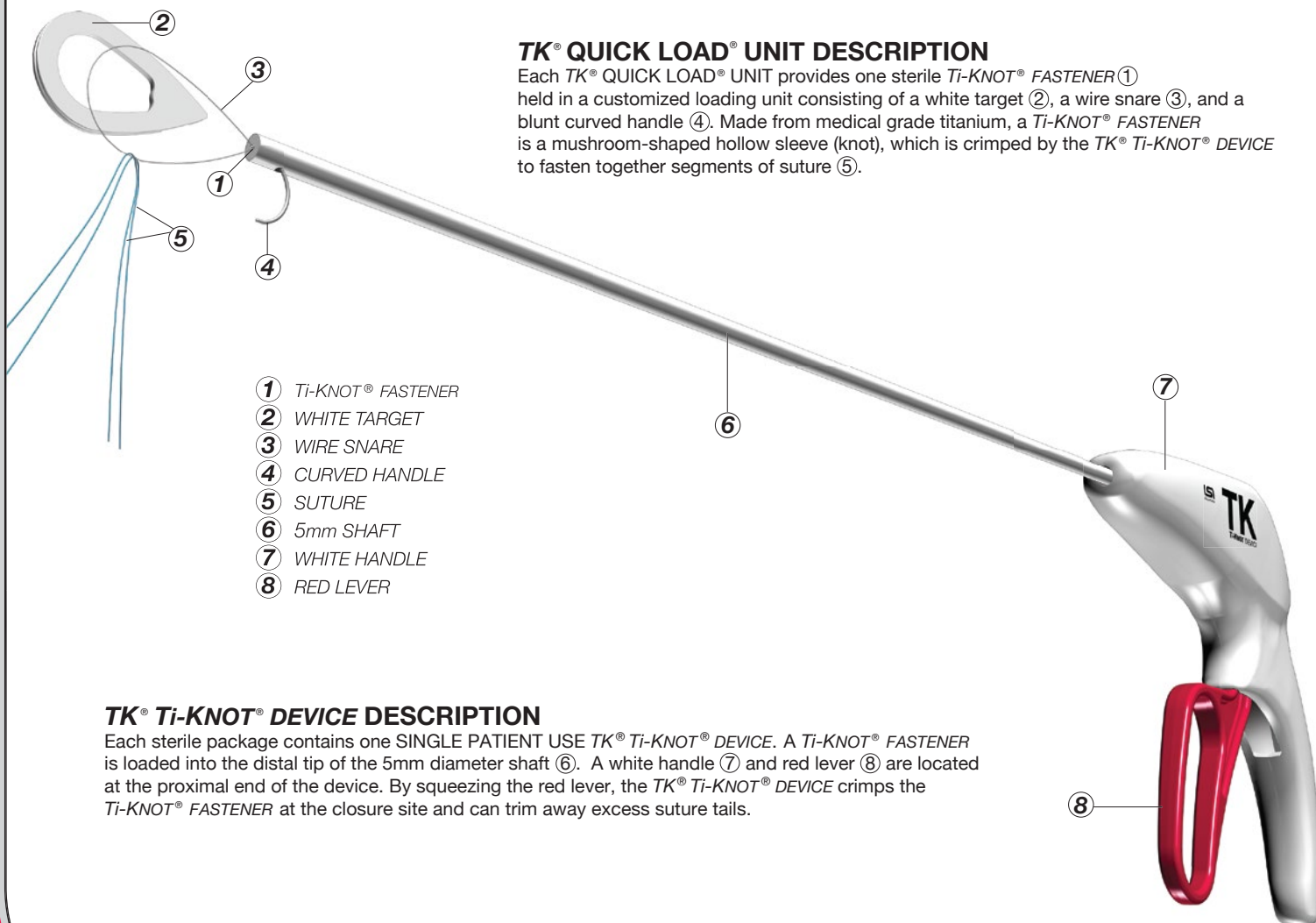

- 1 Ti-KNOT® FASTENER
- 2 WHITE TARGET
- 3 WIRE SNARE
- 4 CURVED HANDLE
- 5 SUTURE
- 6 5mm SHAFT
- 7 WHITE HANDLE
- 8 RED LEVER

## TK® Ti-KNOT® DEVICE DESCRIPTION

Each sterile package contains one SINGLE PATIENT USE TK® Ti-KNOT® DEVICE. A Ti-KNOT® FASTENER is loaded into the distal tip of the 5mm diameter shaft (6). A white handle (7) and red lever (8) are located at the proximal end of the device. By squeezing the red lever, the TK® Ti-KNOT® DEVICE crimps the Ti-KNOT® FASTENER at the closure site and can trim away excess suture tails.

LSOLUTIONS®

FIG. 2

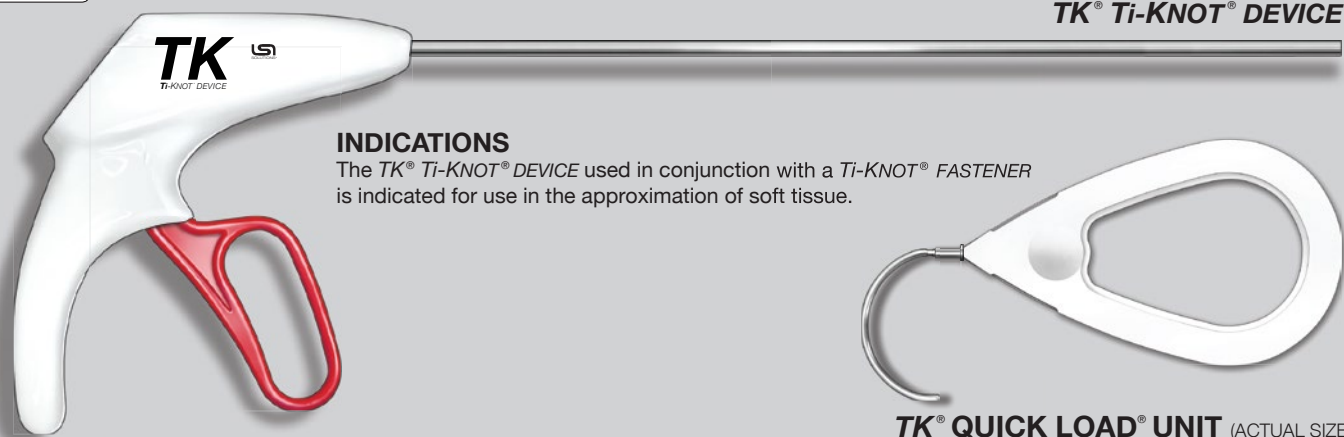

## INDICATIONS

The TK® Ti-KNOT® DEVICE used in conjunction with a Ti-KNOT® FASTENER is indicated for use in the approximation of soft tissue.

TK® QUICK LOAD® UNIT (ACTUAL SIZE)

## AT SCRUB TABLE

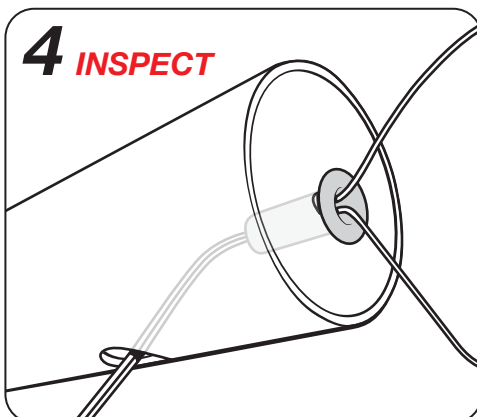
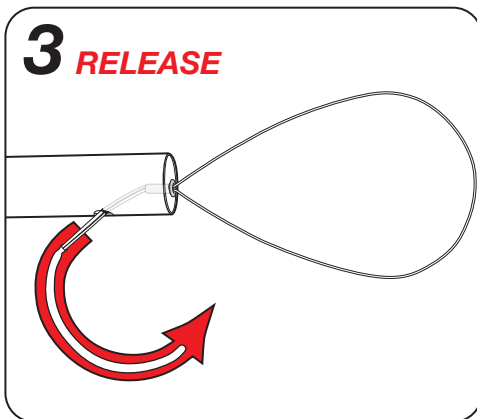
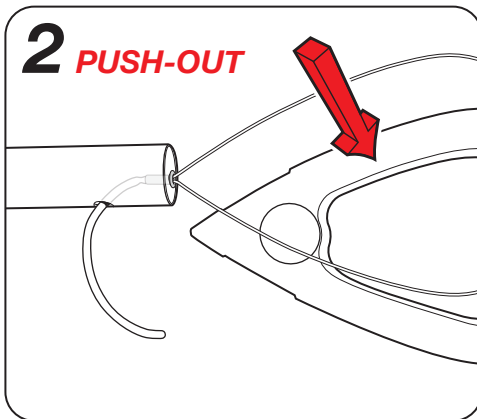
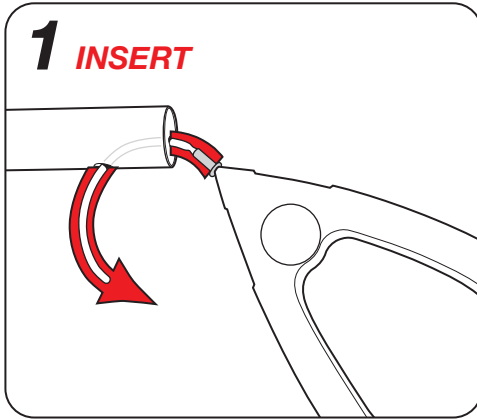

## LOADING A Ti-KNOT® FASTENER WITH A TK® QUICK LOAD® UNIT

Use proper operating room technique to pass the sterile TK® QUICK LOAD® UNIT from its packaging. While maintaining appropriate sterile technique, follow the steps indicated in the illustrations.

- 1. INSERT** the blunt tip of the curved handle into the distal slot at the end of the TK® Ti-KNOT® DEVICE shaft. ROTATE the curved handle through the distal slot and out of the suture hole until the Ti-KNOT® FASTENER occupies the shaft's distal slot. Fully ENGAGE the Ti-KNOT® FASTENER within the tip of the TK® Ti-KNOT® DEVICE by pushing on the white target or by pulling on the curved handle.
- 2. PUSH OUT** and remove the white target.
- 3. RELEASE** the curved handle from the distal slot at the end of the TK® Ti-KNOT® DEVICE shaft.
- 4. INSPECT** to ensure that the Ti-KNOT® FASTENER is well loaded and fully seated.

### ACTIONS

When the TK® Ti-KNOT® DEVICE is loaded with a Ti-KNOT® FASTENER and appropriately positioned at a suture closure site, squeezing the red lever can instantly secure and trim the suture. The surgical titanium used in a Ti-KNOT® FASTENER is not absorbed by the body and is generally not associated with significant inflammatory reactions.

### CONTRAINDICATIONS

- Endoscopic procedures should only be performed by physicians having adequate training and familiarity with endoscopic techniques. Medical literature should be consulted relative to techniques, complications and hazards prior to the performance of endoscopic procedures.
- The TK® QUICK LOAD® UNIT with Ti-KNOT® FASTENER is not intended to be used with any device other than the TK® Ti-KNOT® DEVICE. The TK® Ti-KNOT® DEVICE is not intended to be loaded with anything other than a TK® QUICK LOAD® UNIT with Ti-KNOT® FASTENER.
- The Ti-KNOT® FASTENER is NOT marketed for placement into circulating blood.
- Ti-KNOT® FASTENERS are intended for use only with suture specified by LSI SOLUTIONS®.
- Each TK® Ti-KNOT® DEVICE is not intended to be fired more than 12 times.

### WARNINGS

- Federal (U.S.A.) law restricts this device to sale, distribution and use by, or on, the order of a physician.
- Users should be familiar with standard procedures and techniques involving surgical suture and titanium usage before employing TK® Ti-KNOT® DEVICE with a TK® QUICK LOAD® UNIT for fastening and trimming suture.
- Adequate Ti-KNOT® FASTENER security requires reasonable clinical judgment and appropriate surgical techniques as warranted by surgical circumstances and the experience of the surgeon.
- Excessive suture tensioning can cause suture breakage.
- Single patient use only. Do not reclean or resterilize. Adequate cleaning or removal of blood and other foreign materials from used TK® Ti-KNOT® products cannot be guaranteed. Validation of resterilization is not established. Failure to eliminate inflammatory or infectious agents may cause patient harm. Product functional performance may be compromised in reprocessed devices or Titanium Knots.
- Discard any open (unsealed), unused, expired or damaged TK® QUICK LOAD® UNIT or TK® Ti-KNOT® DEVICE.
- TK® QUICK LOAD® UNIT components and each TK® Ti-KNOT® DEVICE, along with packaging, must be inspected, handled and disposed of consistent with standard, accepted medical device disposal procedures.
- Direct contact between sensitive tissue structures (e.g., pulsatile arteries, cardiac valve leaflets, valve chordae, etc.) and foreign materials can lead to tissue injury or damage, such as tissue erosion. Avoid direct contact between sensitive tissue structures and any knot, including hand-tied or mechanical metal knots, such as a Ti-KNOT® FASTENER.
- As with any foreign body, prolonged contact of any suture with salt solutions, such as those found in the urinary or biliary tracts, may result in calculus formation.
- While the titanium of the Ti-KNOT® FASTENER is physiologically very inert, routine surgical precautions must be employed whenever foreign materials are left in a patient.

### PRECAUTIONS

- When handling the TK® QUICK LOAD® UNIT care should be taken to avoid damage.
- Do not squeeze the red lever of TK® Ti-KNOT® DEVICE while loading the TK® QUICK LOAD® UNIT.
- Irreparable damage to TK® Ti-KNOT® DEVICE suture cutting blade will occur if the red lever is squeezed while the TK® QUICK LOAD® UNIT curved handle is in place at the tip of the instrument.
- Ensure that obstructions do not interfere with the firing of TK® Ti-KNOT® DEVICE.
- Do not squeeze the lever of the loaded TK® Ti-KNOT® DEVICE until the Ti-KNOT® FASTENER has been appropriately positioned directly upon the tissue and the suture accurately tensioned at the targeted site.
- Always squeeze and hold the red lever and then fully release it before pulling the TK® Ti-KNOT® DEVICE tip away from the wound closure site. Failure to appropriately release the red lever can cause suture breakage. Inspect each Ti-KNOT® FASTENER and its suture.
- Do not squeeze the red lever on the same Ti-KNOT® FASTENER more than once.
- Cut suture with scissors if the TK® Ti-KNOT® DEVICE fails to trim suture tails or release Ti-KNOT® FASTENER.
- Avoid crushing or crimping damage to the Ti-KNOT® FASTENER due to inappropriate squeezing of TK® Ti-KNOT® DEVICE red lever and/or to application of surgical instruments like forceps, needle holders, clamps, etc.
- If Ti-KNOT® FASTENER falls out of tip or is not properly loaded, retrieve loose FASTENER, reload with new FASTENER and start again.
- If the red lever of the TK® Ti-KNOT® DEVICE does not return completely forward on its own (i.e., without assistance), manually push the lever forward all the way to release the Ti-KNOT® FASTENER.
- Check for hemostasis or leakage where appropriate.
- Before endoscopic instruments and accessories from different manufacturers are employed together in a procedure, verify compatibility and ensure that electrical isolation or grounding are not compromised.

### ADVERSE REACTIONS

Adverse effects associated with the use of surgical suture and titanium can include, but are not limited to: wound dehiscence, thrombus formation, embolism, calculi formation in urinary and biliary tracts when prolonged contact with salt solutions such as urine and bile occurs, infected wounds, minimal acute inflammatory tissue reaction, and transitory local irritation. Surgical titanium is not absorbed by the body and is generally not associated with inflammatory reactions.

## OUTSIDE OF CANNULA

**5 PASS**

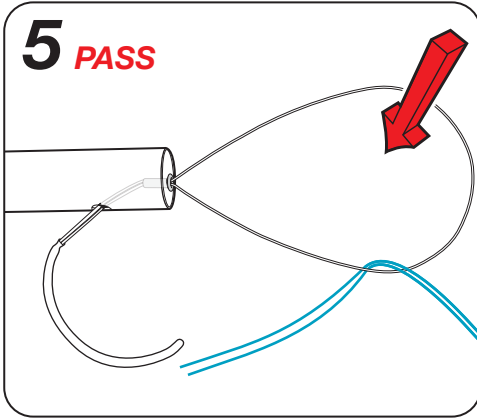

**6 PULL**

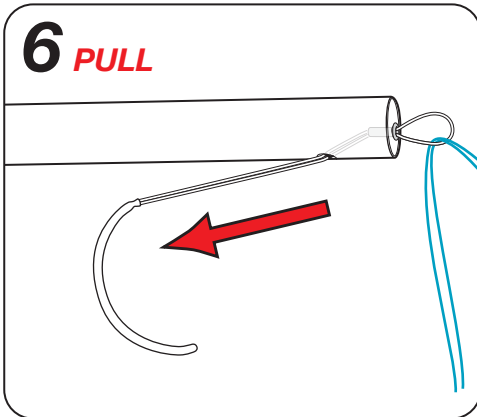

**7 THREAD**

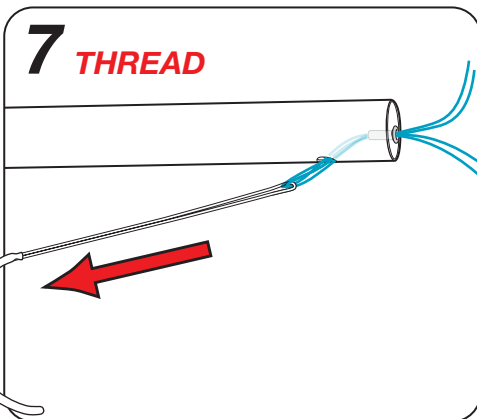

**8 GRASP**

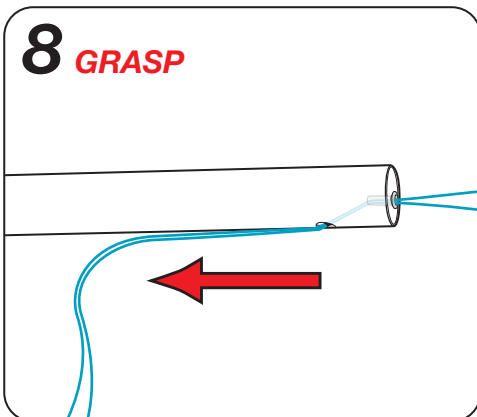

## THREADING SUTURE THROUGH A LOADED Ti-KNOT® FASTENER

Extracorporeally: surgeons typically use their non-dominant hand to hold the device near the end of its shaft and their dominant hand to complete the suture threading technique.

5. **PASS** both ends of the suture through the open wire snare at the end of the shaft.
6. **PULL** the curved handle with its attached wire snare containing the suture ends towards the red lever to draw the snared bends in the suture into the **Ti-KNOT® FASTENER**.
7. **THREAD** the suture through the **Ti-KNOT® FASTENER** and out of the suture hole near the end of the shaft by continuing to pull the curved handle until the wire snare and both ends of the suture exit through the suture hole.
8. **GRASP** both ends of the suture after passing off the curved handle with the wire snare.

**9 SLIDE**

## INSIDE OF PATIENT

9. **SLIDE** the **Ti-KNOT® FASTENER** over the partially tensioned suture down to the targeted site.

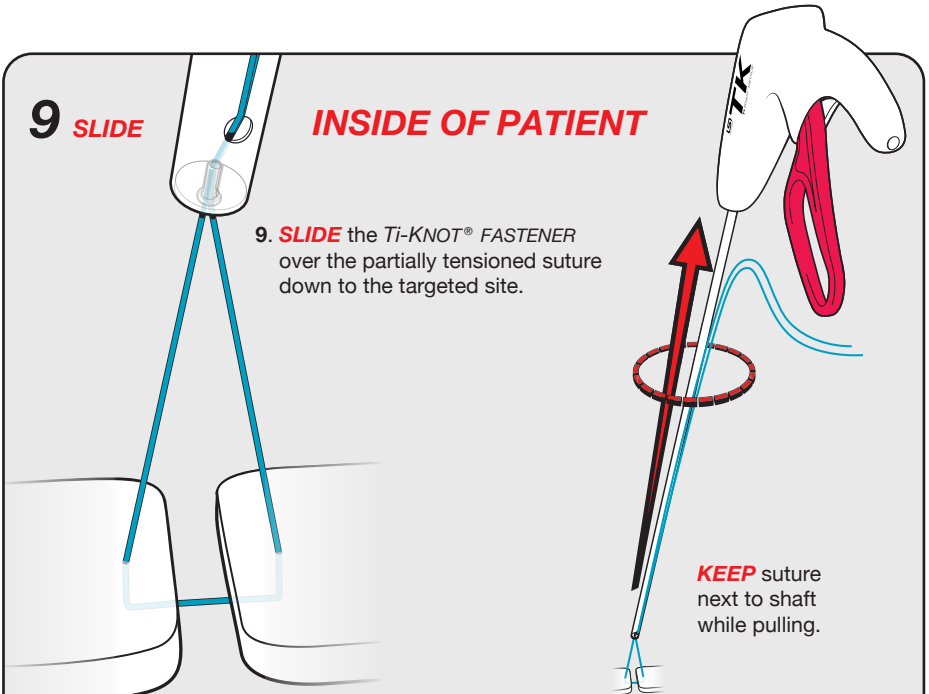

**10**

**SQUEEZE & HOLD**

1 Second

To crimp **Ti-KNOT® FASTENER**

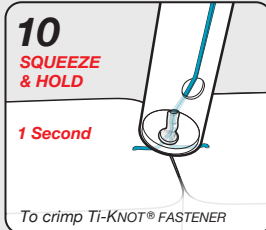

**11**

**TUG & RELEASE**

Tug to trim suture tails

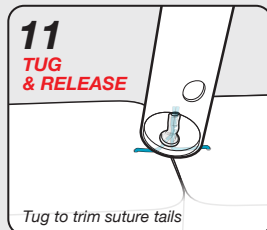

**12**

**REMOVE DEVICE**

Inspect **Ti-KNOT® FASTENER**

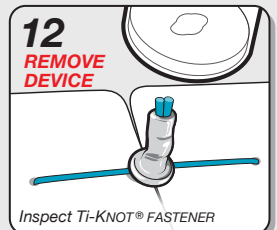

## SQUEEZE & HOLD / TUG & RELEASE / REMOVE DEVICE

With the distal tip on the targeted site, use one hand to apply sufficient suture tension to hold tissue in appropriate apposition, then the other hand to:

10. **SQUEEZE** the red lever until it stops, maintain the device tip's position, **HOLD** lever for one second.
11. **TUG** the suture gently to cut free both suture tails and **RELEASE** the red lever fully to release the crimped **Ti-KNOT® FASTENER**.
12. **REMOVE DEVICE** and inspect to ensure **Ti-KNOT® FASTENER** and suture tails are oriented away from delicate tissue.

**PLEASE NOTE** While very rapidly squeezing and releasing of the red lever provides average suture holding forces above USP standards, this recommended **SQUEEZE & HOLD** technique takes only one second longer and assures extra knot suture holding force. Visually inspect each suture and **Ti-KNOT® FASTENER**.

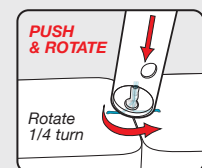

**(OPTIONAL)** If the crimped **Ti-KNOT® FASTENER** does not readily release from the distal tip, ensure red lever is released, then gently **PUSH** inward and **ROTATE** the handle 90° about the shaft. If still necessary, **ROTATE** the handle back and then turn 90° in the opposite direction.

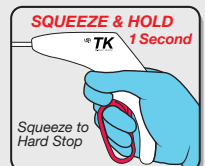

## FAILURE TO PROPERLY LOAD SUTURE

NOTE: TO REMOVE A RETAINED **Ti-KNOT® FASTENER** IF THE WIRE SNARE IS INADVERTENTLY REMOVED WITHOUT PROPER SUTURE THREADING, ENSURE THE **TK® Ti-KNOT® DEVICE** IS OUTSIDE OF THE PATIENT, THEN SQUEEZE AND RELEASE THE RED LEVER AND THEN TAP THE DISTAL SHAFT ON A TABLE OR USE A SCALPEL TO PRY OUT THE CRIMPED **Ti-KNOT® FASTENER**.

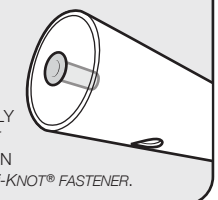

# TK® QUICK LOAD® UNIT WITH Ti-KNOT® FASTENER

READ PRODUCT INSERT THOROUGHLY BEFORE USE

FIG. 3

## CRIMPED Ti-KNOT® FASTENER

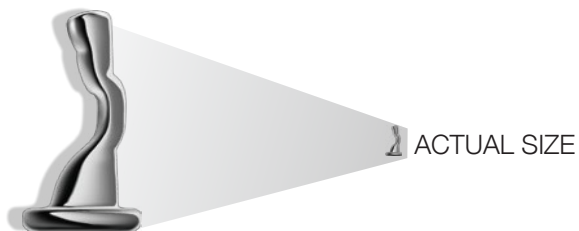

ACTUAL SIZE



## TK® QUICK LOAD® UNIT

- ① Ti-KNOT® FASTENER
- ② WHITE TARGET
- ③ WIRE SNARE
- ④ CURVED HANDLE

## TK® QUICK LOAD® UNIT DESCRIPTION

Each TK® QUICK LOAD® UNIT provides one sterile Ti-KNOT® FASTENER ① held in a customized loading unit consisting of a white target ②, a wire snare ③, and a blunt curved handle ④. Made from medical grade titanium, a Ti-KNOT® FASTENER is a mushroom-shaped hollow sleeve (knot), which is crimped by the TK® Ti-KNOT® DEVICE to fasten together segments of suture.

# Ti-KNOT® DEVICE MISCELLANEOUS

FIG. 4

“ONLY THE SURGEON SQUEEZES THE RED LEVER.”

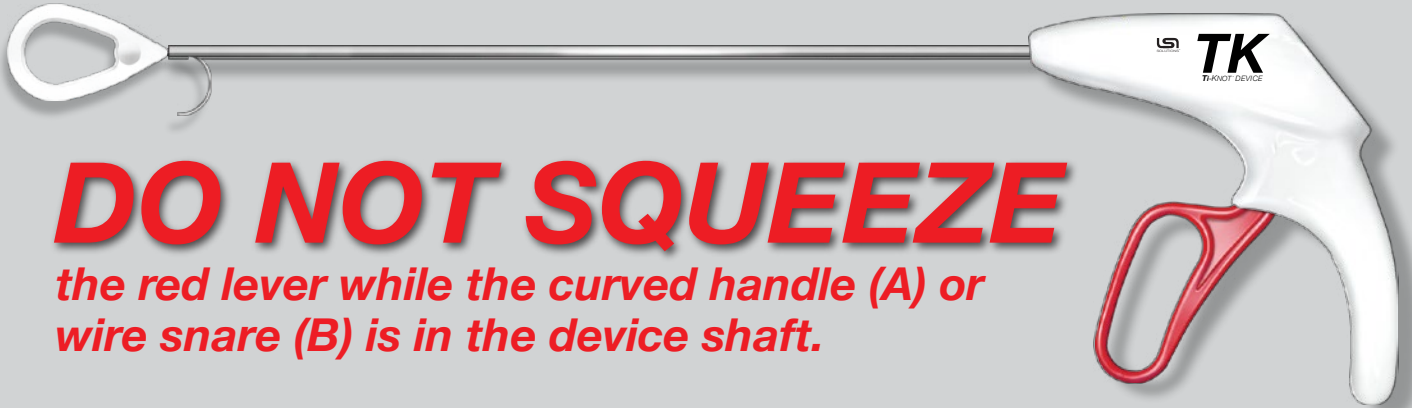

**DO NOT SQUEEZE**

*the red lever while the curved handle (A) or wire snare (B) is in the device shaft.*

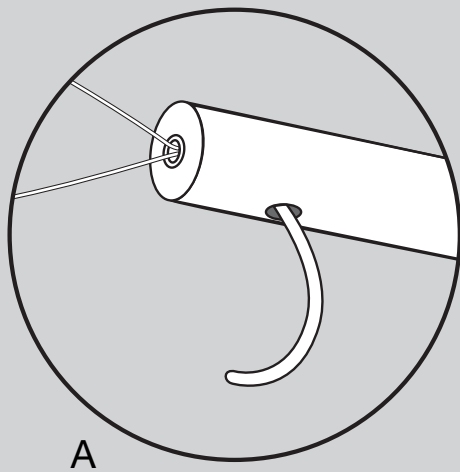

A

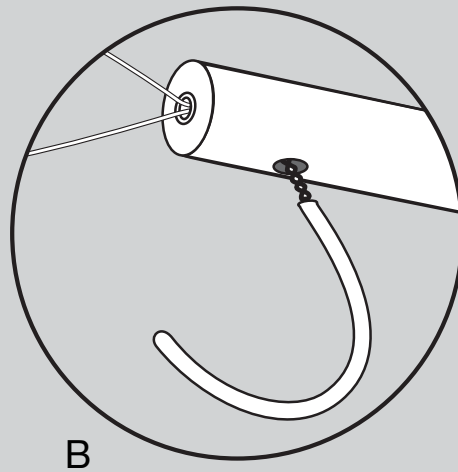

B

**SUTURE CUTTING DIFFICULTY**—THE CAUSES OF SUTURE NOT CUTTING EASILY WHEN USING A *Ti-KNOT® DEVICE* CAN INCLUDE:

- USER ERROR INDUCED DAMAGE DULLING THE SUTURE CUTTING BLADE OR
- DEVICE MALFUNCTION, WHICH MAY ALSO REDUCE FASTENER STRENGTH AND SECURITY

If suture cutting difficulty occurs while using any *Ti-KNOT® DEVICE*, discontinue its intraoperative use and **REMOVE DEVICE** from the surgical field. Visually **INSPECT FASTENER** to compare its crimp to other fasteners. Pull or tug on the fastener with a forceps or clamp to **TEST FASTENER** and suture security.

**REMOVE DEVICE—INSPECT FASTENER—TEST KNOT—RETURN DEVICE**



*Ti-KNOT® DEVICE* suture cutting difficulty can be induced by the inadvertent squeezing of the red lever while the metal loading components are still in the distal device shaft. This user error can lead to irreparable damage to the suture cutting blade by driving the blade into the metal curved handle or metal wire snare

## MRI TESTING

Based on MRI testing information, titanium *Ti-KNOT® FASTENERS* will not present an additional hazard or risk to a patient undergoing an MRI procedure using a scanner operating with a static magnetic field of 3-Tesla or less and under the MRI-related heating conditions (MRI for 15 min. at an MR system reported whole body averaged specific absorption rate, SAR, value of 3-W/kg).

**TK® PRODUCT ORDERING**

**SUPPLIED: STERILE INDIVIDUALLY PACKAGED**

	REORDER	PRODUCT	DESCRIPTION
 x 6	REF 030404	<b>TK® Ti-KNOT® DEVICE</b>	Box of 6 DEVICES
 x 12	REF 030510	<b>TK® QUICK LOAD® UNIT</b>	Box of 12 QUICK LOAD® UNITS

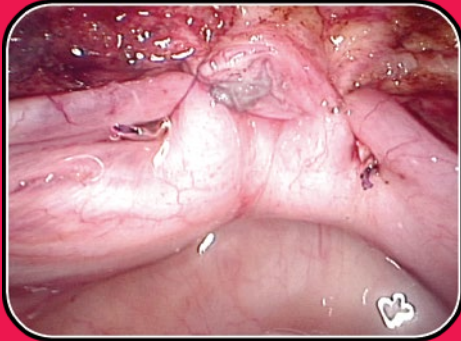

Titanium Fasteners immediately after TLH

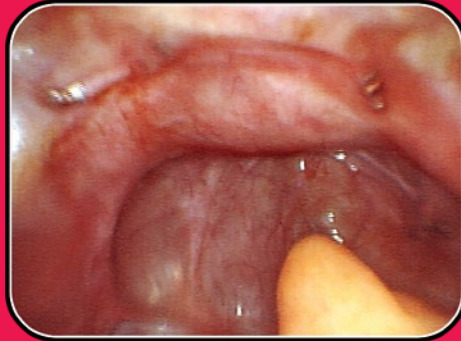

Encapsulated Titanium Fasteners  
3 months after TLH



Titanium Fasteners in porcine tissue

**LSI SOLUTIONS®**

Patents: [www.lsisolutions.com/patents](http://www.lsisolutions.com/patents)

The LSI logo, LSI SOLUTIONS, TK, Ti-Knot, Quick Load, and Perfect Performance Policy are trademarks and registered trademarks of LSI Solutions, Inc. Copyright © 2007, LSI SOLUTIONS®. All Rights Reserved.



Symbol Glossary: [www.lsisolutions.com/symbols](http://www.lsisolutions.com/symbols)



**LSI SOLUTIONS®**  
7796 Victor-Mendon Road  
Victor, New York 14564 U.S.A.  
Phone: 585.869.6600  
Customer Service: 866.575.3493  
Technical Support: 866.428.9092  
Fax: 585.742.8086  
[www.lsisolutions.com](http://www.lsisolutions.com)

**MADE IN THE USA**

This Product Comes  
with our LSI SOLUTIONS®  
**Perfect Performance Policy®**  
Call us at 866.575.3493 any time.